

ROPEYE TDP

Ropeye Through-Deck Pushing prevents premature wear to deck and rope. Must always be used for installing Loops and Twinlines.



Ropeye TDP



Ropeye Double TDP

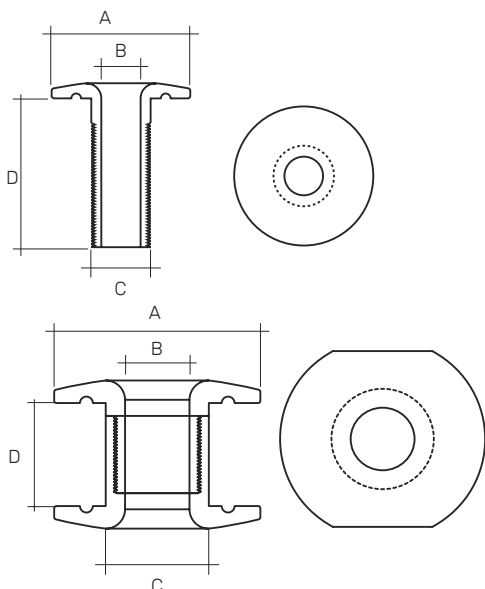

Ropeye TDP

TDP C	A Head Ø mm	B Inner Ø mm	C Outer Ø mm	D Length mm	Weight g	Material
TDPXS	20	6	9	10	2.5	Anodised Aluminium
TDP12	28	8	12	30	8.5	Anodised Aluminium
TDP14	30	10	14	30	10	Anodised Aluminium
TDP16	32	12	16	30	11	Anodised Aluminium
TDP18	34	14	18	30	13	Anodised Aluminium

Ropeye Double TDP

TDP B/D	A Head Ø mm	B Inner Ø mm	C Outer Ø mm	D Length mm	Weight g	Material
ROTDP10/10-12	32	9.5	16	10-12	13	Anodised Aluminium
ROTDP10/12-16	32	9.5	16	12-16	13.5	Anodised Aluminium
ROTDP10/16-22	32	9.5	16	16-22	15	Anodised Aluminium
ROTDP10/22-30	32	9.5	16	22-30	15.5	Anodised Aluminium
ROTDP10/30-50	32	9.5	16	30-50	20	Anodised Aluminium
ROTDP14/10-12	40	12	20	10-12	20	Anodised Aluminium
ROTDP14/12-16	40	12	20	12-16	24	Anodised Aluminium
ROTDP14/16-22	40	12	20	16-22	26	Anodised Aluminium
ROTDP14/22-30	40	12	20	22-30	25	Anodised Aluminium
ROTDP14/30-50	40	12	20	30-50	29.5	Anodised Aluminium
ROTDP18/10-12	48	14	24	10-12	35.5	Anodised Aluminium
ROTDP18/12-16	48	14	24	12-16	37	Anodised Aluminium
ROTDP18/16-22	48	14	24	16-22	41	Anodised Aluminium
ROTDP18/22-30	48	14	24	22-30	44	Anodised Aluminium
ROTDP18/30-50	48	14	24	30-50	52	Anodised Aluminium
ROTDP28/15-20	60	20	28	15-20	170	Corrax
ROTDP28/20-30	60	20	28	20-30	184	Corrax
ROTDP28/30-50	60	20	28	30-50	207	Corrax
ROTDP28/50-90	60	20	28	50-90	257	Corrax
ROTDP32/15-20	60	24	34	15-30	180	Corrax
ROTDP32/20-30	60	24	34	20-30	196	Corrax
ROTDP32/30-50	60	24	34	30-50	228	Corrax
ROTDP32/50-90	60	24	34	50-90	292	Corrax

INSTALLATION

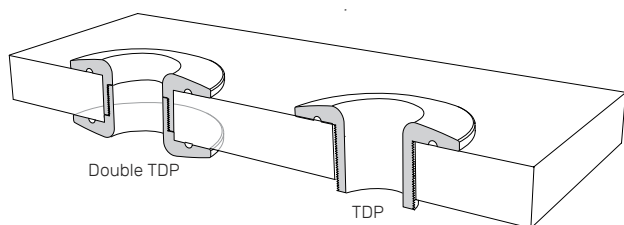

Drill a hole for the TDP. Clean the installation area with acetone to remove dust and grease. Apply Sikaflex 291i or other adhesive to make the installation area watertight. When installing the double TDP, apply adhesive to the bottom TDP and tighten it.

Adjustable Double TDP is entirely waterproof, strengthens the deck, and protects it against abrasion.

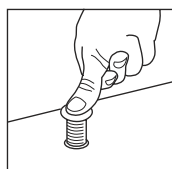

ATTENTION

- DRILL THE INSTALLATION HOLE THE RIGHT SIZE
- DO NOT EXCEED SAFE WORKING LOAD

IF YOU NEED ANY HELP ON INSTALLATION SEND AN EMAIL TO: SALES@ROPEYE.COM

ROPEYE PRODUCTS HAVE A 2 YEAR WARRANTY



www.ropeye.com